

Proyecto Nuevo Almacén Granos (Fase 1)

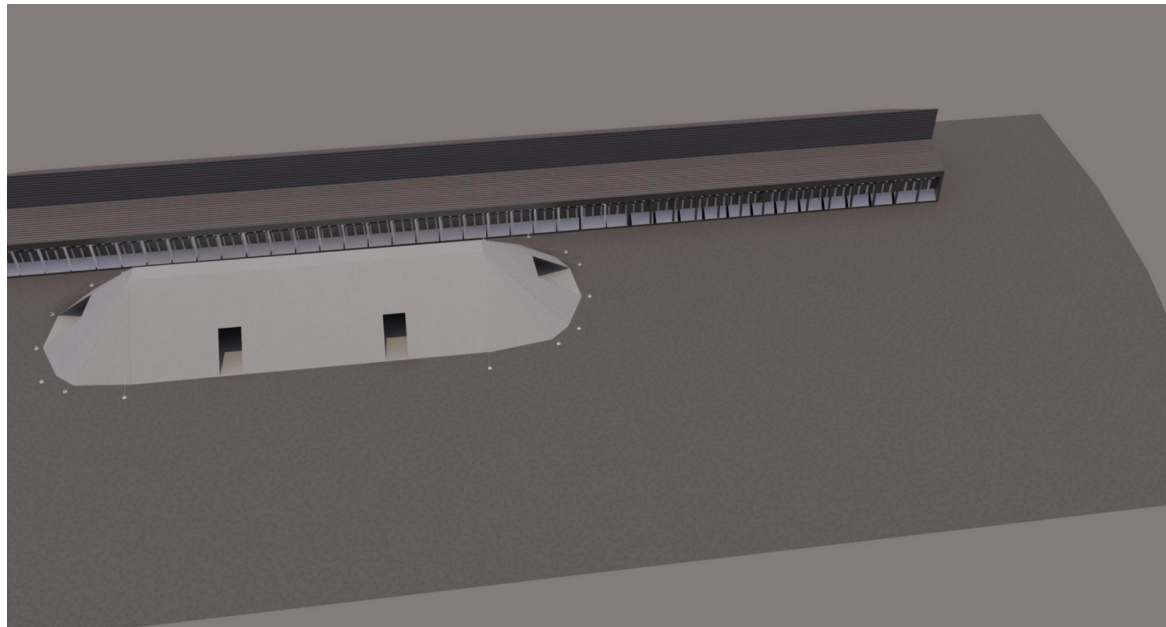

Fase	Almacenamiento (m3)		En ton	
	Por Fase	Acumulado	Por Fase	Acumulado
Fase 1	51,154	51,154	40,923	40,923
Fase 2	72,046	123,200	57,637	98,560
Fase 3	51,154	174,354	40,923	139,483
Fase 4	72,046	246,400	57,637	197,120
Fase 5	183,331	429,731	146,665	343,785

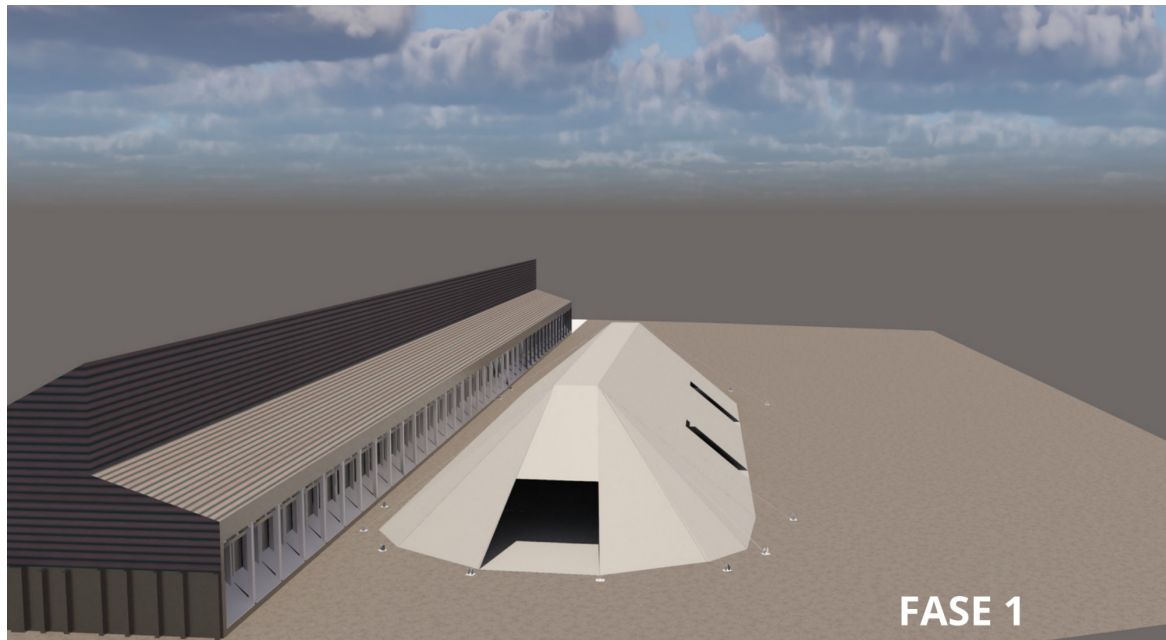
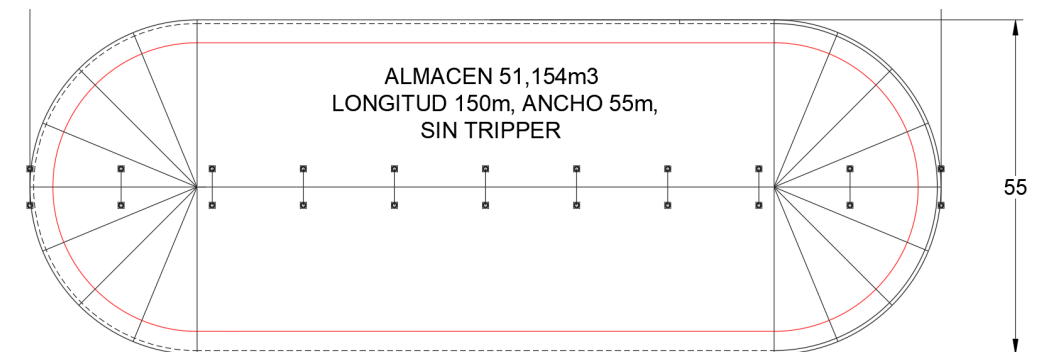
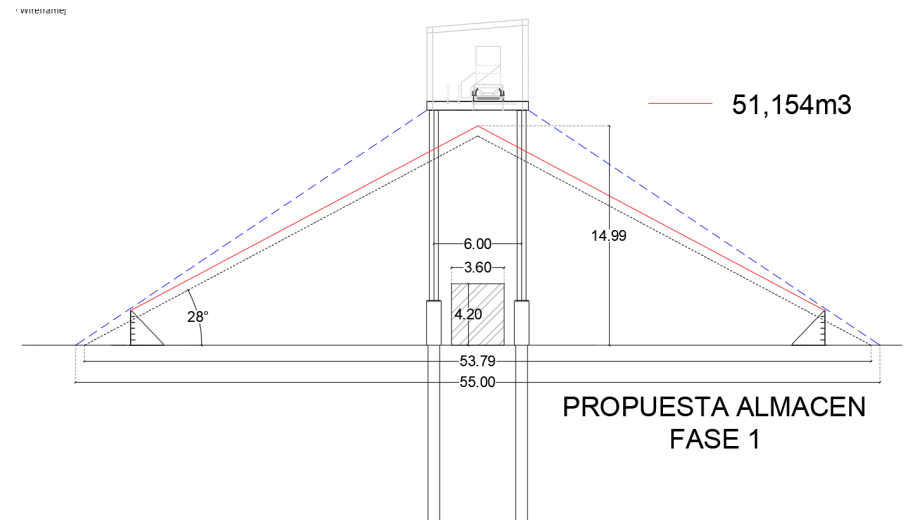

Proyecto Nuevo Almacén Granos (Fase 5)

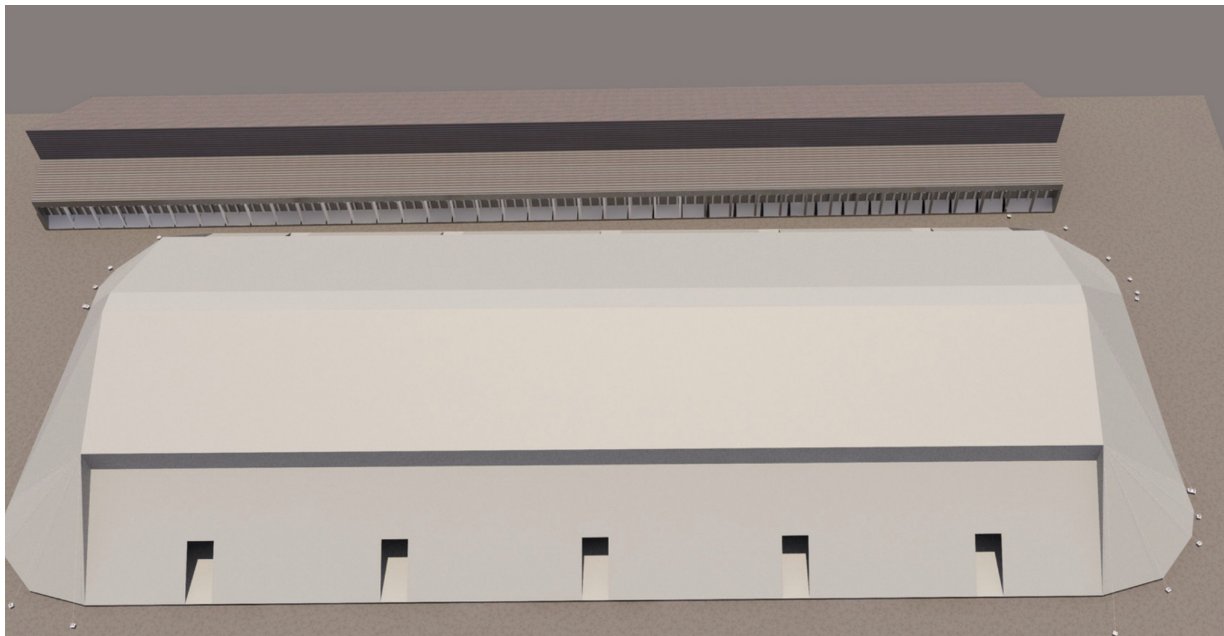
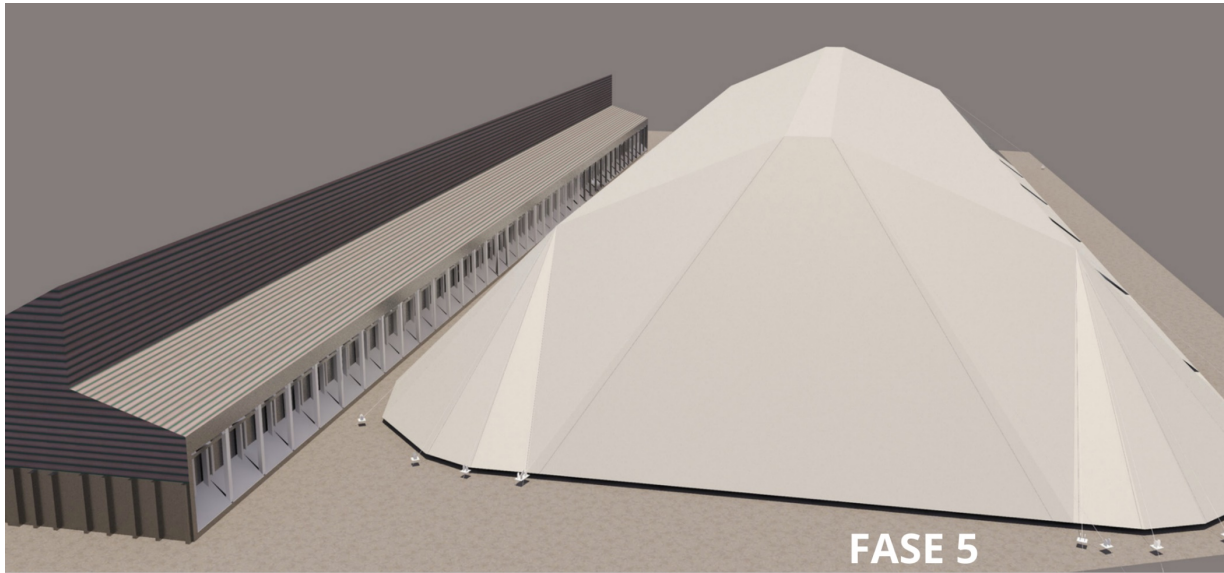

Fase	Almacenamiento (m3)		En ton	
	Por Fase	Acumulado	Por Fase	Acumulado
Fase 1	51,154	51,154	40,923	40,923
Fase 2	72,046	123,200	57,637	98,560
Fase 3	51,154	174,354	40,923	139,483
Fase 4	72,046	246,400	57,637	197,120
Fase 5	183,331	429,731	146,665	343,785

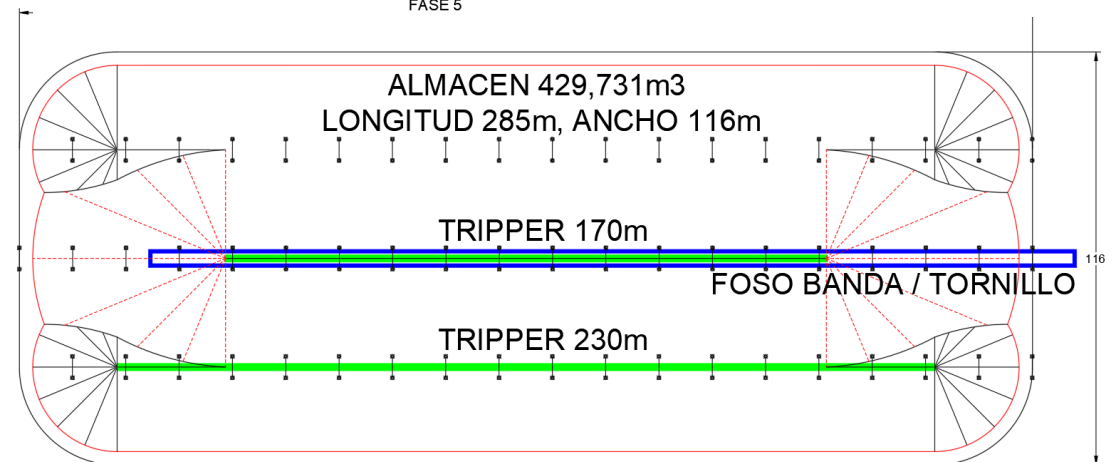
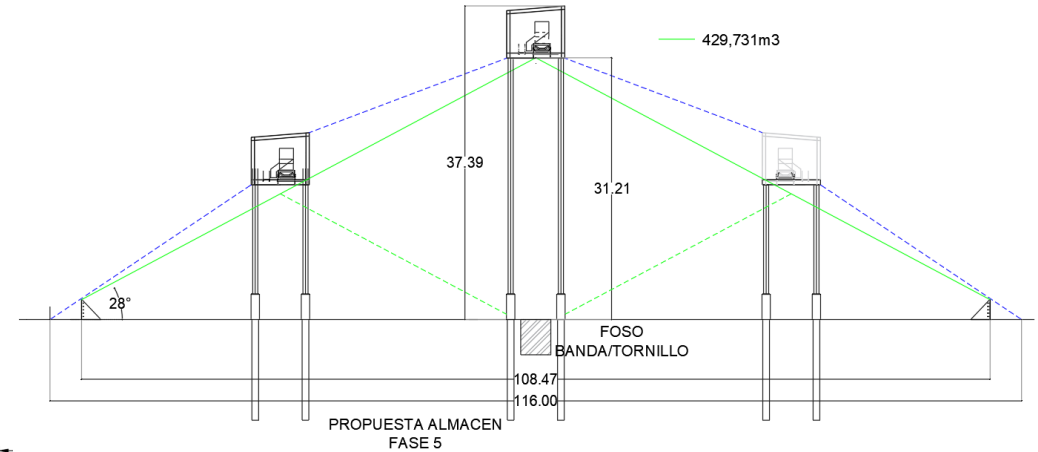

MAPA DE RUTAS FERROVIARIARIAS

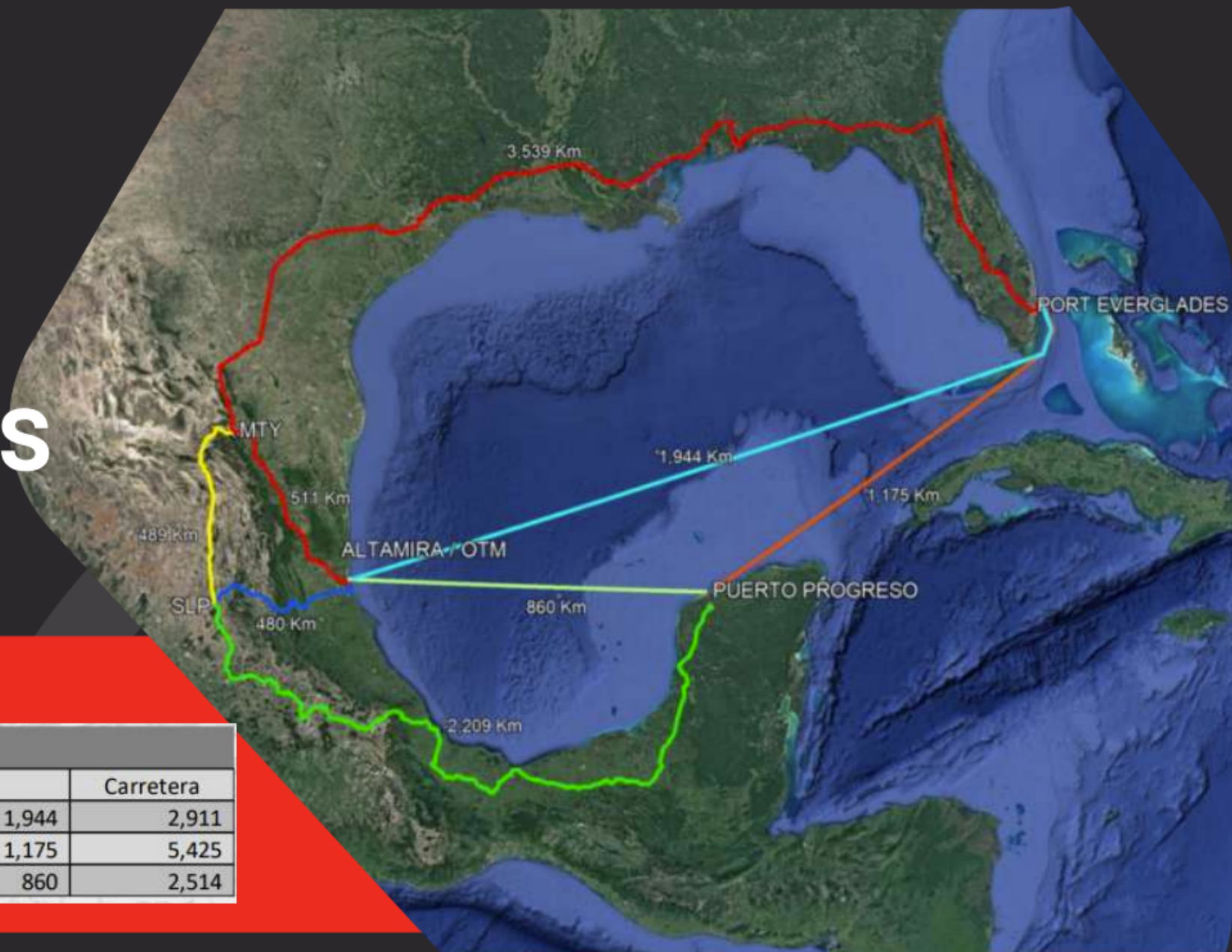

Cuadro de Distancias (km)

	FFCC	Mar	Carretera
Port Everglades - Altamira	3,539	1,944	2,911
Port Everglades - Progreso	5,726	1,175	5,425
Altamira - Progreso	2,689	860	2,514